



 **ADVANCED**
MOTION CONTROLS

Everything's possible.

Servo Drive Overview

Sold & Serviced By:
 **ELECTROMATE**

Toll Free Phone (877) SERV098
Toll Free Fax (877) SERV099
www.electromate.com
sales@electromate.com



About ADVANCED Motion Controls

ADVANCED Motion Controls has earned a reputation for being a flexible and affordable manufacturer of quality high performance and high power density servo drives. Camarillo California is home to our state-of-the-art 80,000 square foot facility that integrates Engineering, Manufacturing, Testing and Support in a single location. Using our standard product line as a starting point our customers know they can specify modifications and custom solutions to solve their specific problems. This frees our customers to design systems without the constraints imposed by other servo drive manufacturers.

Any Motor, Any Controller, Any Feedback!

Our core business is servo drives. We offer hundreds of standard models, and if we don't have what you need we can work with you to create a custom solution that does. Our servo drives can be found all over the world in the highest performance applications, the harshest environments as well as working reliably in day to day operations throughout the world.



25 Years of Excellence

25 years of servo drive manufacturing, with over 2 million servo axes built and shipped worldwide!

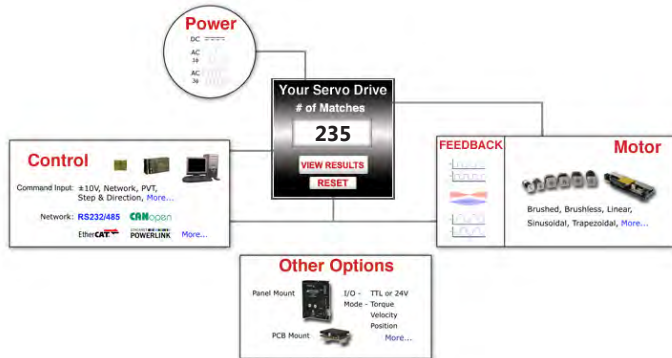

Finding the right ADVANCED Motion Controls' servo drive for your application is easy. Enter key parameters into the Automated Servo Drive Selection Tool at www.a-m-c.com, and automatically receive a list of servo drives that meet your requirements. You can also browse through our Servo Drive Family Product Tables, or if you already know the model number, simply enter it into the Product Resource Center to find the appropriate datasheet, installation manual, and product drawing.



Product Resource Center
(Datasheets & Support)

DZEANTU-020B080

Enter the **base part number** only
example: 12A8 - Not 12A5M

DZCANTE-025L200
DZCANTE-040L080
DZCANTE-060L080
DZEANTU-020B080
DZRALTE-010L200

Select

Family Description		Power	Mode of Operation	Command	Feedback	
Top Level Features and Attributes:						
Plug-In Mount '2-Drives'	Series	Description	Motor Type	Power		
				Voltage [V]	Current [A]	
			Brushed /brushless	AC	DC	
	AZ	Analog Brushed & Brushless (10 & 30)	✓	✓	10 - 175	6 - 40
	AZX	Analog Extended Environment	✓	✓	10 - 80	8 - 25
	D2C	DigiFlex Performance™ CANopen	✓	✓	10 - 175	12 - 40
	D2E / D2S	DigiFlex Performance™ EtherCAT	✓	✓	18 - 80	20 - 10
	D2B	DigiFlex Performance™ RS-485/232	✓	✓	10 - 175	12 - 40
	D2X	DigiFlex Performance™ CANopen/232	✓	✓	10 - 175	8 - 40
Panel Mount	A, B0, B2, B3	Analog Brushed & Brushless (10 & 30)	✓	✓	120 - 230	20 - 400
	brushed	Analog Brushed (10 motors/loads)	✓	✓	120	20 - 400
	DPC	DigiFlex Performance™ CANopen	✓	✓	230 - 460	20 - 800
	DPE	DigiFlex Performance™ EtherCAT	✓	✓	180 - 240	120 - 200
	DPS	DigiFlex Performance™ RS-485/232	✓	✓	230 - 460	20 - 800
Vehicle Mount	S, SX	External Sine Commutation	✓	✓	120 - 230	20 - 400
	AB	General Industrial	✓	✓	20 - 175	100 - 250
	AVB	Electric Mobility and Vehicle	✓	✓	20 - 175	100 - 250
	DVC	DigiFlex Performance™ CANopen Electric Mobility and Vehicle	✓	✓	20 - 175	100 - 250

ADVANCED Motion Controls Servo Drive Overview

Sold & Serviced By:



Toll Free Phone (877) SERV098
 Toll Free Fax (877) SERV099
www.electromate.com
sales@electromate.com

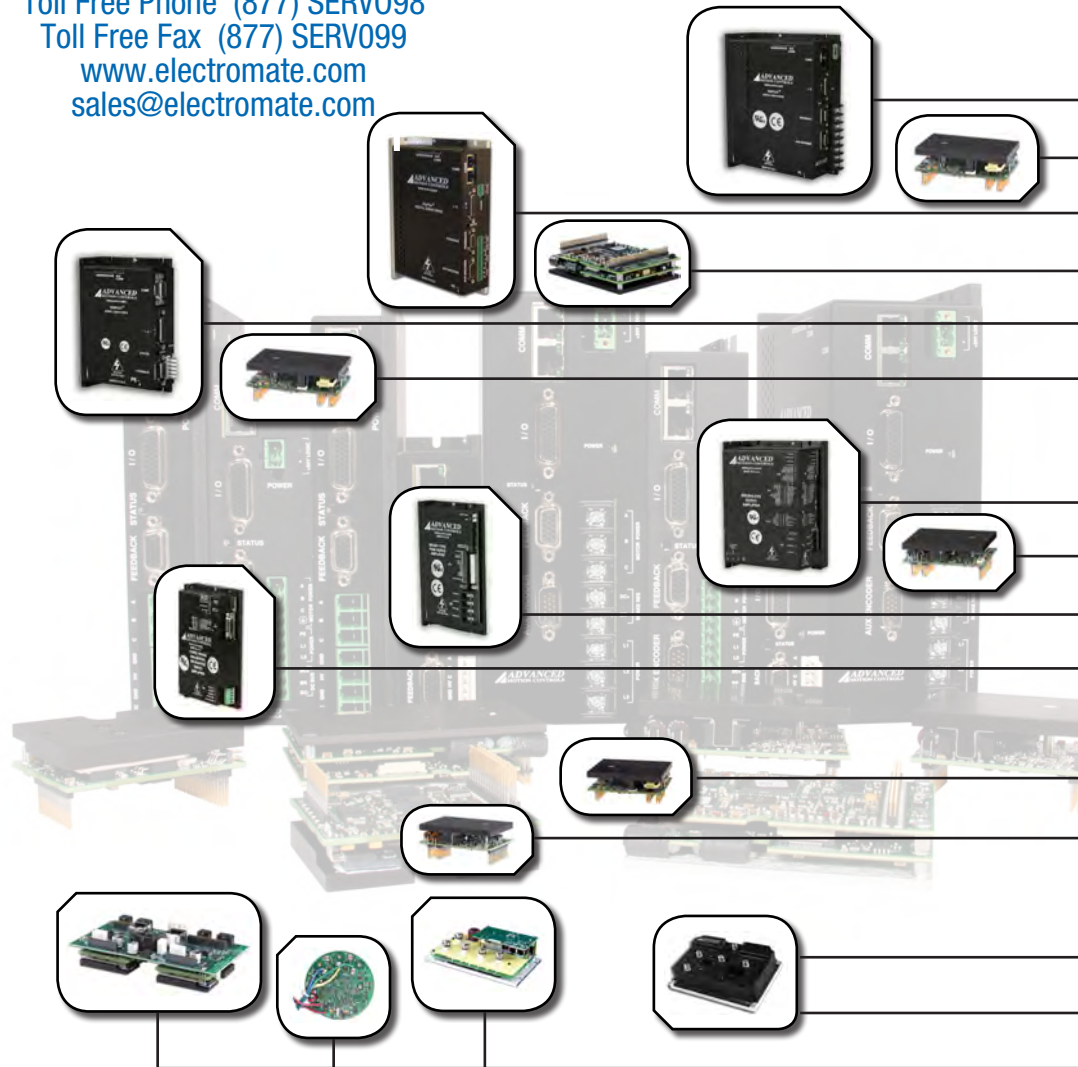

Company and Product Capabilities	1
Click&Move®	3
DigiFlex® Performance™ Digital Servo Drives	5
DPC series - CANopen panel mount	7
DZC series - CANopen pcb mount	8
DPE series - EtherCAT® panel mount	9
DZE/DZS series - EtherCAT® pcb mount	10
DPR series - RS485/232 panel mount	11
DZR series - RS485/232 pcb mount	12
Analog Servo Drives	13
B, BD, BE, and BX series - Brushless panel mount	15
AZ series - Brushless/Brushed pcb mount	16
Brushed panel mount	17
S series - Sinusoidal commutation drives	18
Extended Environment Servo Drives	19
DZX series - Extended Environment digital pcb mount	21
AZX series - Extended Environment analog pcb mount	22
M/V™ Series Vehicle Mount Motor Controllers	23
DVC series - vehicle mount digital motor controllers	25
AVB/AB series - vehicle mount analog motor controllers	26
Custom Servo Drive Capabilities	27



For Company Information, Product Datasheets, Installation Manuals and Downloads visit www.a-m-c.com



Company and Product Capabilities



Sold & Serviced By:
ELECTROMATE
 Toll Free Phone (877) SERV098
 Toll Free Fax (877) SERV099
www.electromate.com
sales@electromate.com

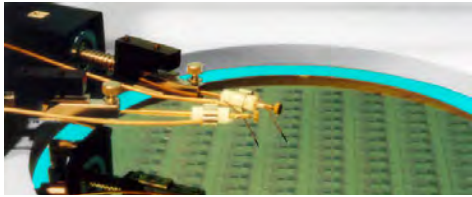

Networks

ADVANCED Motion Controls offers a variety of network options for connecting servo drives in a multi-axis configuration. Choosing the right network depends on a variety of factors such as required bandwidth, update rate, performance, and cost. Currently supported network options are: CANopen, EtherCAT®, RS232, RS485.



EtherCAT® - EtherCAT is a registered trademark and patented technology, licensed by Beckhoff Automation GmbH, Germany. The ADVANCED Motion Controls' EtherCAT interface follows the ETG.1000.6 EtherCAT Application Layer protocol specification and the ETG.6010 Implementation guideline for CiA402 drive profile.

CANopen - An open standard embedded machine control protocol developed for the CAN physical layer, following the CiA (CAN in Automation) DS301 communications profile and the CiA DSP402 device profile

RS485/232 - ADVANCED Motion Controls' proprietary serial protocol, a byte-based, binary, master-slave standard to access drive commands.

We also have the ability to quickly produce custom DigiFlex® drives utilizing Ethernet TCP/IP, Ethernet Powerlink, or many other common types of network communication.

Motors

As a company whose core business is servo drives we have to be compatible with as many motors and motor technologies as possible. We have servo drives that work with: Brushed DC, Brushless: AC & DC, Linear & Rotary, AC Induction, Voice Coil, Trapezoidal & Sinusoidal commutation. Many of our drives can work with all of the above with only a few minor configuration settings.

Feedback

To give our customers the greatest flexibility we offer a wide variety of motor feedback options. Standard feedback options include: Halls, Incremental Encoder, Resolver, 1Vp-p Sine/Cosine Encoder, Stegmann Hiperface®, Heidenhain EnDat® and Tachometer. On our DigiFlex® Performance™ drives we also have the option for auxiliary feedback for dual loop control.

Accessories

As a convenience to our customers we offer power supplies, filter cards, shunt regulators and mounting cards to complement our servo drives.





Technology and Solutions to Problems

Combining cutting-edge technology and creative engineering, *ADVANCED* Motion Controls is able to design and manufacture high quality servo drives capable of delivering high power at a low cost. As the demands of the motion control industry have increasingly asked for better performance, more features, and simplified integration, *ADVANCED* Motion Controls has responded by finding resourceful solutions to the problems faced by OEMs and servo system designers. Whether by implementing innovative design techniques throughout our line of standard products, or by directly solving a specific customer's application with a brand-new custom product, *ADVANCED* Motion Controls has the drive expertise to take on your servo system challenge.

Applications and Industries

ADVANCED Motion Controls is able to utilize our extensive experience in providing high performance servo drives to support motion control applications in numerous industries. With an ever-expanding customer base across new and emerging fields, and having been established as a top supplier for traditional servo solutions, *ADVANCED* Motion Controls brings our wealth of diverse motion control knowledge to a wide variety of industries, including but not limited to:



Assembly Automation and General Factory Machinery



Communications Control



Electric Mobility and Mobile Robotics



Entertainment



Homeland Security and Defense



Inspection Testing and Rapid Prototyping



Lab Automation



Machine Tool and Metalworking



Material Handling and Conveyed Systems



Medical



Packaging



Power Generation and Alternative Energy Sources



Robotics (fixed)



Semiconductor



Simulators



Sold & Serviced By:

 **ELECTROMATE**

Toll Free Phone (877) SERV098

Toll Free Fax (877) SERV099

www.electromate.com

sales@electromate.com



Click&Move® (C&M®) Software

Click&Move® is a Windows-based soft motion and automation solution that uses function blocks described under IEC 61131-3 as the programming method. Function block programming allows non-programmers to fully develop and implement motion control and automation programs in a GUI environment. Click&Move also includes a built in graphical HMI that displays the machine operation on screen.

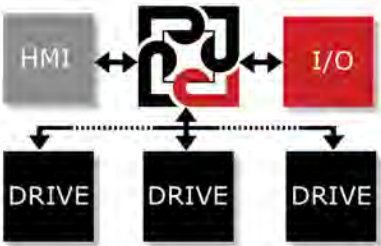
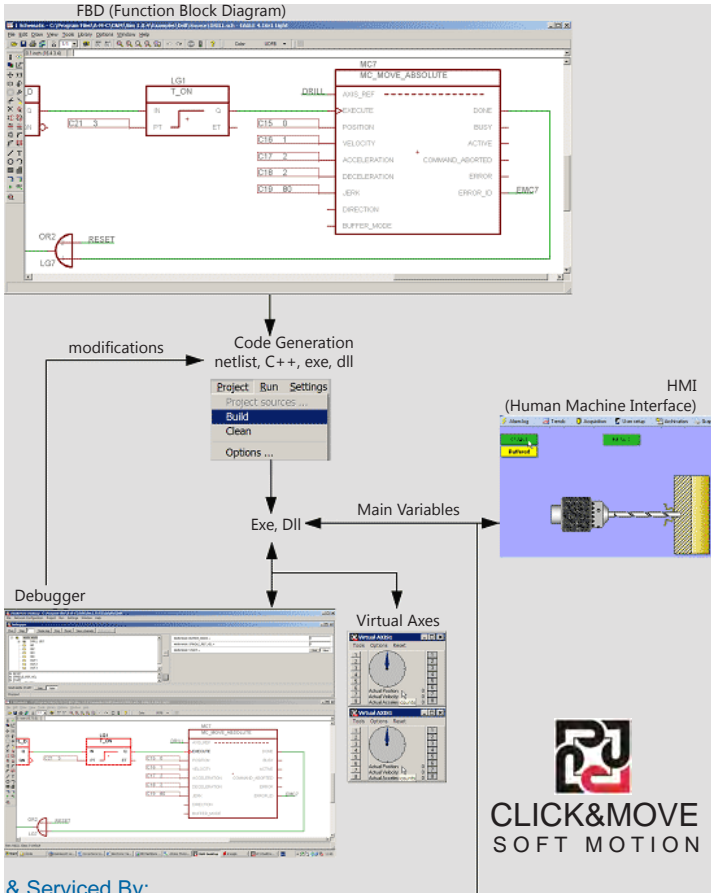

- Standard PLCopen Function Blocks library for Motion Control is included
- New Function Blocks can also be created with an encapsulated user C++ program.

Click&Move® programs can run on Windows based PC's, Motion Automation Control Cards (MACC), or on embedded *ADVANCED* Motion Controls' servo drives, all at low cost to solve a variety of applications. Using the PC based approach provides for servo drive and I/O command update rates in the millisecond range.

Motion Automation Control Card (MACC)

ADVANCED Motion Controls has designed a dedicated MACC with embedded Click&Move® programming capability. Key highlights are:

- Based on an ARM microprocessor operating with real-time Linux
- Stand-alone card with network connections, and can be optionally packaged in a standard DIN rail plastic case
- External I/O module connectivity
- Optional plug-in I/O module with dedicated and user-defined digital and analog I/O

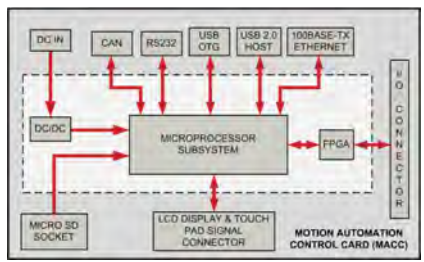

- The MACC serves as a general purpose motion/automation controller:
- Controlling a network of digital drives and I/Os
 - Controlling servo drives with ±10V torque or velocity command inputs for lower cost/higher update rate solution
 - Fully functional PLC utilizing C&M programmability and I/O modules

The C&M user program can be developed, compiled and tested on a PC and simply recompiled for the MACC platform. Once downloaded into the MACC, it can also be debugged via Ethernet UDP/IP. The program may also be controlled/monitored in real time via the UDP/IP connection by a PC with a client C&M application.

C&M programs can also be distributed between the PC and the MACC; the fast, time critical portion of the application can run in the MACC while C&M's HMI and slower portions run in the PC. Connections are made via Ethernet.

The number of motion axes is only limited by the axis update rate. This axis update rate is influenced by the size and complexity of the C&M application program.

Sold & Serviced By:
ELECTROMATE
 Toll Free Phone (877) SERV098
 Toll Free Fax (877) SERV099
www.electromate.com
sales@electromate.com

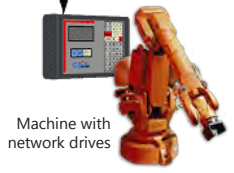

Optional PC with Windows®
(w/ or w/out keyboard)

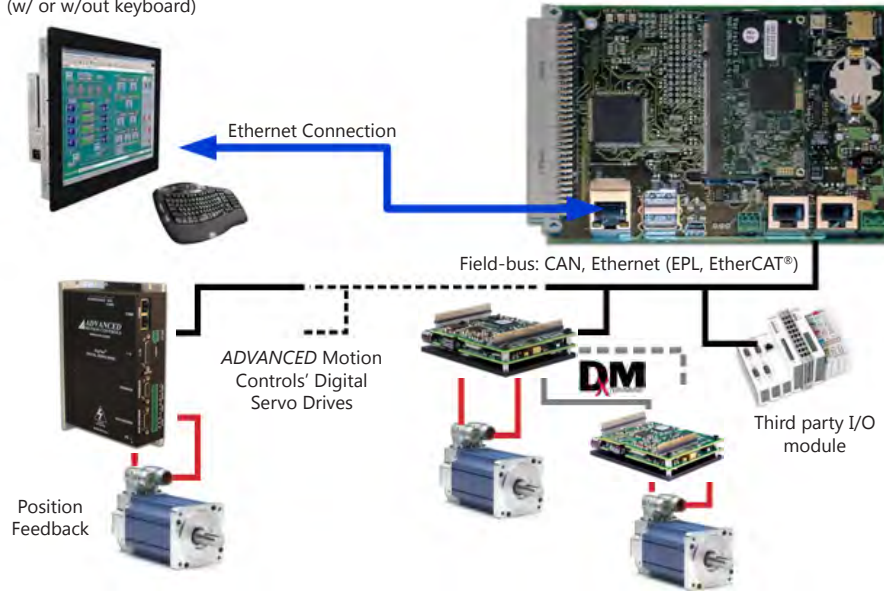

MACC with Network Drives and I/O Modules

This solution can meet demands for drive and I/O command update rates in the few hundred microseconds range. The MACC integrates field bus masters, such as EtherCAT® or Ethernet Powerlink (EPL), directly or they can be installed into an external PC.

To lower drive system costs, *ADVANCED* Motion Controls' exclusive 'DxM' Technology can be utilized. Using only one EtherCAT® drive, other sub-nodes could be readily connected.

& MOVE® SOLUTION

CLICK AUTOMATION

MACC with Torque or Velocity Mode Drives

The analog outputs of the plug-in I/O module of the MACC are connected to the $\pm 10V$ input of torque or velocity mode drives. Non-networked servo drives, combined with the MACC, provide a system with the lowest overall cost.

This solution can meet demands for drive and I/O command update rates in the 50 microsecond range. However, due to noise and wiring considerations, cable length between the drives/motors and the controller is limited to within a few meters. In this case, motor feedback connections are made to the external I/O module's dedicated inputs.

To provide additional I/Os, pins of the MACC's FPGA are buffered and brought out to an optional connector which can be used by a plug-in I/O expansion card with an SSI (synchronous serial interface).

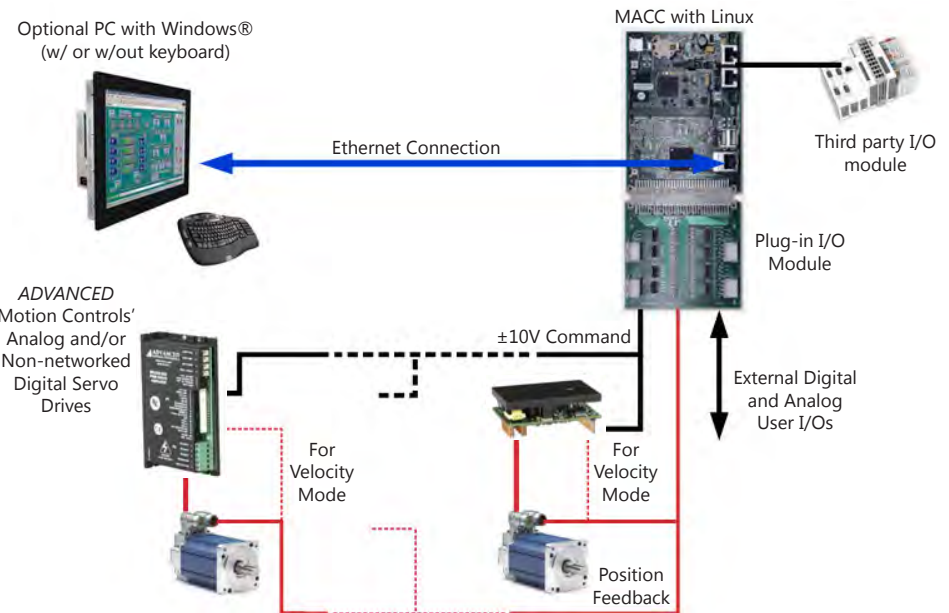

DigiFlex® Performance™ Digital Servo Drives



The family of DigiFlex® Performance™ digital servo drives provide a wide range of options for servo system solutions. DigiFlex® Performance™ (DP) drives deliver peak power output from 1.5 to 27.4kW, and support an array of feedback options. Driving single phase, three phase, and closed loop vector motors with the ability to interface with both digital network commands and traditional $\pm 10V$ analog commands, DP drives offer a versatile blend of cutting edge technology and proven results.

- **Universal servo motor capability by means of automatic commutation adjustment**
- **Variety of feedback options - Absolute Encoder (Heidenhain EnDat® or Stegmann Hiperface®), Sin/Cos Encoder, Incremental Encoder, Hall Sensors, Resolver, Tachometer**
- **Full tuning control of Position, Velocity, and Torque Loops**
- **Real-time oscilloscope for high-performance tuning**
- **Status panel for drive and system diagnostics**
- **I/O configuration for over 60 events and signals**
- **Dual loop feedback and control - increases stability and accuracy**
- **Stand-alone or network configuration**
- **Standard models in both Panel Mount, PCB Mount (Z-Drives), and Vehicle Mount (M/V™ Series Motor Controllers)**
- **Employs Space Vector Modulation, resulting in higher bus voltage utilization and reduced heat dissipation**
- **Extended Environment versions available (DZX series Z-Drives)** Sold & Serviced By:



Toll Free Phone (877) SERV098
 Toll Free Fax (877) SERV099
www.electromate.com
sales@electromate.com



DIGIFLEX® PERFORMANCE™



Any Controller



Any Motor



Any Feedback



Any Network



Any Environment

ADVANCED Motion Controls' Exclusive Innovations in EtherCAT® Connectivity

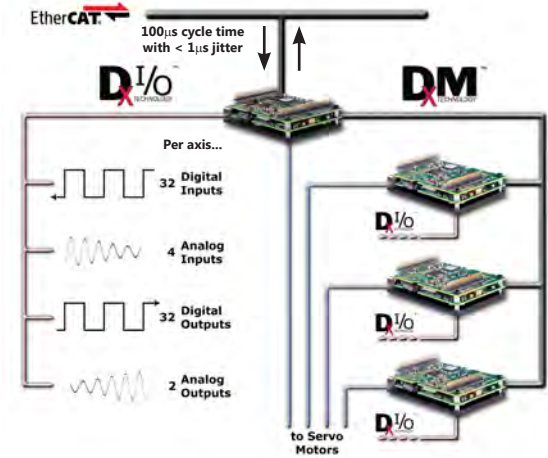

'DxM'™ Technology allows connectivity of up to 3 DZS (sub-nodes) to a single DZE (node) on an EtherCAT® network, providing control of up to 4 axes of servo motion at a reduced cost.

'DxI/O'™ Technology accommodates 70 additional digital and analog I/O points for each axis in a 'DxM' configuration, up to 280 I/O total!



Sold & Serviced By:

ELECTROMATE

Toll Free Phone (877) SERV098
 Toll Free Fax (877) SERV099
www.electromate.com
sales@electromate.com



DriveWare® 7

DriveWare® 7 is the powerful servo drive tuning and configuration software used to commission and troubleshoot all ADVANCED Motion Controls DigiFlex® Performance™ digital servo drives. All drive limits, control loops (current, velocity, and position), and event handling can be configured in DriveWare. Notable features include a fully functional multi-channel oscilloscope, function generator and user friendly layout and interface.

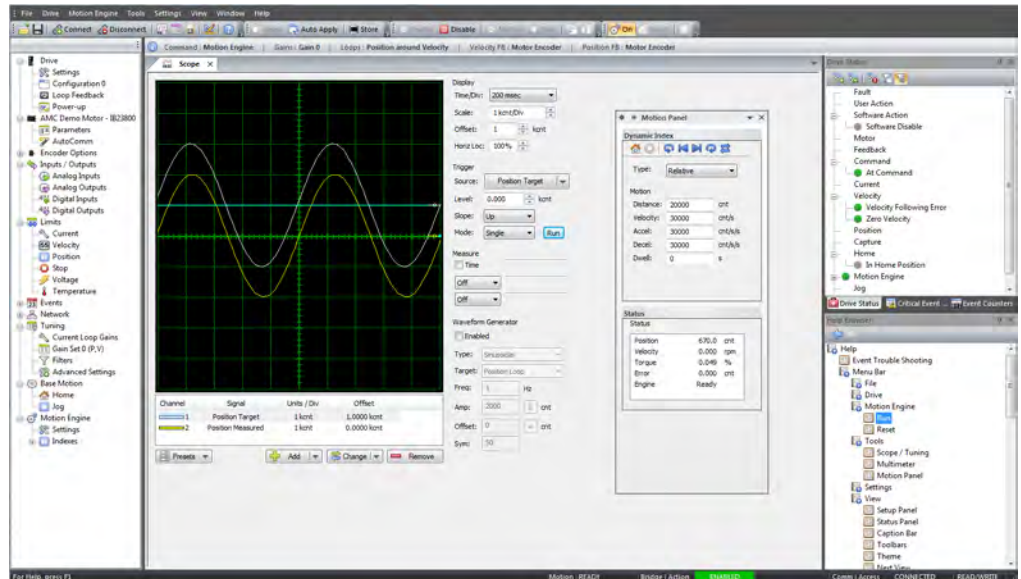

DPC series - CANopen panel mount



Panel Mount Drives

DPC drives are enclosed by a metal cover and can be mounted on their spine or flat against the base.

Communication

- CANopen Networking
- RS232 Drive Commissioning

Command Types

- Over the Network
- ±10V Analog
- PWM and Direction
- Encoder Following
- Indexing
- Jogging

Power Range

- 1.5 - 27.4 kW Peak Power Output
- 0.8 - 13.7 kW Cont. Power Output

Primary Feedback

- Absolute Sin/Cos Encoder (Heidenhain EnDat® or Stegmann Hiperface®)
- 1Vp-p Sin/Cos Encoder
- Incremental Encoder
- Resolver

Auxiliary Feedback

- Hall Sensors
- Aux. Incremental Encoder
- Tachometer

To build a model number, select a control module by feedback type, then combine with a power module that suits your system's requirements. 24 VDC I/O Control Modules combine with AC Power Modules, and 5VTTL I/O Control Modules combine with DC Power Modules.

CANopen



Combine to form model number

	24 VDC I/O Control Modules						
	DPCANIA-	DPCANIE-	DPCANIR-	DPCANIS-			
Feedback	Absolute Encoder	Incremental Encoder	Resolver	Sin/Cos Encoder			
	AC Power Modules						
	015S400	015A400	030A400	C060A400	C100A400	030A800	060A800
Supply (VAC)	100-240*	100-240	100-240	200-240	200-240	200-480	200-480
Peak Current (A)	15	15	30	60	100	30	60
Cont. Current (A)	7.5	7.5	15	30	50	15	30
Dimensions (mm)	177 x 123 x 44	177 x 140 x 56	202 x 157 x 70	257 x 183 x 84	257 x 183 x 135	301 x 232 x 92	301 x 232 x 139

*Single Phase AC Only

Combine to form model number

	5VTTL I/O Control Modules				
	DPCANTE-	DPCANTR-			
Feedback	Incremental Encoder	Resolver			
	DC Power Modules				
	020B080	040B080	060B080	015B200	025B200
Supply (VDC)	20-80	20-80	20-80	40-190	20-190
Peak Current (A)	20	40	60	15	25
Cont. Current (A)	10	20	30	7.5	12.5
Dimensions (mm)	133 x 90 x 36	191 x 112 x 36	191 x 112 x 36	133 x 90 x 36	191 x 112 x 36

Sold & Serviced By:

ELECTROMATE

Toll Free Phone (877) SERV098

Toll Free Fax (877) SERV099

www.electromate.com

sales@electromate.com

ISO9001
CERTIFIED

cRU[®] US CE RoHS

ADVANCED
MOTION CONTROLS

DZC series - CANopen pcb mount

Z-Drives Plug-In Integration

DZC drives are packaged in a lightweight and compact form factor designed to be embedded directly into a PCB - no wires required! Inverted baseplate mounting also allows for direct wired connector access. A common footprint is used for the different power modules in the series to simplify prototyping.

Communication

- CANopen Networking
- USB Drive Commissioning (DZCANTU)
- RS232 Drive Commissioning (DZCANTE)

Command Types

- Over the Network
- ±10V Analog
- PWM and Direction
- Encoder Following
- Indexing
- Jogging

Power Range

- 0.9 - 4.6 kW Peak Power Output
- 0.5 - 2.3 kW Cont. Power Output

Firmware Selectable Feedback (DZCANTU)

- Absolute Sin/Cos Encoder (Heidenhain EnDat® or Stegmann Hiperface®)
- 1Vp-p Sin/Cos Encoder
- Incremental Encoder

Primary Feedback (DZCANTE)

- Incremental Encoder

Auxiliary Feedback

- Hall Sensors
- Aux. Incremental Encoder
- Tachometer

To build a model number, choose a control module then combine with a power module to meet your system's requirements. Note that only certain power modules can be combined with each respective control module.

Control Module				Combine to form model number	Control Module					
DZCANTU-Feedback			DZCANTE-Feedback							
	Absolute Encoder Incremental Encoder Sin/Cos Encoder				Incremental Encoder					
DZCANTU DC Power Modules				DZCANTE DC Power Modules						
	020B080	040B080	020B200		012L080	020L080	040L080	060L080	010L200	025L200
Supply (VDC)	20-80	20-80	40-175	Supply (VDC)	20-80	10-80	10-80	10-80	40-175	40-175
Peak Current (A)	20	40	20	Peak Current (A)	12	20	40	60	10	25
Cont. Current (A)	10	20	10	Cont. Current (A)	6	12	20	30	5	12.5
Dimensions (mm)	90 x 64 x 20	90 x 64 x 20	90 x 64 x 20	Dimensions (mm)	64 x 51 x 18	64 x 51 x 23	76 x 51 x 23	76 x 51 x 23	64 x 51 x 23	76 x 51 x 23
Example: DZCANTU-020B080				Example: DZCANTE-040L080						

ADVANCED Motion Controls offers mounting cards and mating connector kits to simplify the connections between DZC drives and external system hardware (motors, feedback devices, controllers). These mounting cards are ideal for the prototyping and development stages as well as implementation into the final system design.

DZCANTU Mounting Cards**

	Axes	Motor/Power Connector	Max Voltage	Max Peak Current
MC1XDZPC01	1	Side-entry screw terminal	175	40

**Mating connector housing and socket contacts can be ordered as a kit using ADVANCED Motion Controls' part numbers KC-MC1XDZP01.

DZCANTE Mounting Cards†

	Axes	Motor/Power Connector	Max Voltage	Max Peak Current
MC1XDZC02	1	Side-entry screw terminal	175	40
MC1XDZC02-QD	1	Vertical-entry quick-disconnect	175	25
MC1XDZC02-HP1	1	Side-entry screw terminal	80	60

†Mating connector housing and socket contacts can be ordered as a kit using ADVANCED Motion Controls' part number KC-MC1XDZ02.

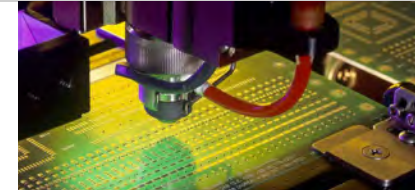

CANopen



Sold & Serviced By:

ELECTROMATE

Toll Free Phone (877) SERV098

Toll Free Fax (877) SERV099

www.electromate.com

sales@electromate.com

ISO9001
CERTIFIED

RoHS

CE

cRU[®] US

ADVANCED
MOTION CONTROLS

DPE series - EtherCAT® panel mount

Panel Mount Drives

DPE drives are enclosed by a metal cover and can be mounted on their spine or flat against the base.

Communication

- EtherCAT® Networking - (CoE - based on DSP-402 device profile)
- USB Drive Commissioning

Command Types

- Over the Network
- +/-10V Analog
- Encoder Following
- Indexing
- Jogging

Power Range

- 1.5 - 27.4 kW Peak Power Output
- 0.8 - 13.7 kW Cont. Power Output

Firmware Selectable

Primary Feedback

- Absolute Sin/Cos Encoder (Heidenhain EnDat®, Stegmann Hiperface®, or BiSS C-Mode)
- 1Vp-p Sin/Cos Encoder
- Incremental Encoder

Auxiliary Feedback

- Hall Sensors
- Aux. Incremental Encoder
- Tachometer

To build a model number, combine the DPEANIU control module with a power module to meet your system's requirements.

EtherCAT®



Combine to form model number

24 VDC I/O Control Module

DPEANIU-

Absolute Encoder
Incremental Encoder
Sin/Cos Encoder

Feedback

Universal Feedback

DPE drives support all the listed feedback devices simply by changing the drive firmware. The appropriate firmware can be uploaded to the drive through DriveWare® and is included with the software download.

AC Power Modules

	015S400	030A400	C060A400	C100A400	030A800	060A800
Supply (VAC)	100-240*	100-240	200-240	200-240	200-480	200-480
Peak Current (A)	15	30	60	100	30	60
Cont. Current (A)	7.5	15	30	50	15	30
Dimensions (mm)	177 x 123 x 44	202 x 157 x 70	257 x 183 x 84	257 x 183 x 135	301 x 232 x 92	301 x 232 x 139

*Single Phase AC Only

DC Power Module

020B080

Supply (VDC)	20-80
Peak Current (A)	20
Cont. Current (A)	10
Dimensions (mm)	167 x 90 x 36

Examples:
DPEANIU-015S400
DPEANIU-020B080

ISO9001
CERTIFIED

cRU[®] US CE RoHS

ADVANCED
MOTION CONTROLS

Sold & Serviced By:

ELECTROMATE

Toll Free Phone (877) SERV098

Toll Free Fax (877) SERV099

www.electromate.com

sales@electromate.com

DZE/DZS series - EtherCAT® pcb mount

Z-Drives Plug-In Integration

DZE/DZS drives are packaged in a lightweight and compact form factor designed to be embedded directly into a PCB - no wires required! Inverted baseplate mounting also allows for direct wired connector access. A common footprint is used for the different power modules in the series to simplify prototyping.

Communication

- EtherCAT® Networking - (CoE - based on DSP-402 device profile)
- 'DxM'™ Technology
- USB Drive Commissioning

Command Types

- Over the Network
- ±10V Analog
- Encoder Following
- Indexing
- Jogging

Power Range

- 1.5 - 3.3kW Peak Power Output
- 0.8 - 1.6kW Cont. Power Output

Firmware Selectable Feedback

- Absolute Sin/Cos Encoder (Heidenhain EnDat® or Stegmann Hiperface®)
- 1Vp-p Sin/Cos Encoder
- Incremental Encoder

Auxiliary Feedback

- Hall Sensors
- Aux. Incremental Encoder
- Tachometer

To build a model number, select a control module based on the EtherCAT® node type and combine with a power module to meet your system's requirements.

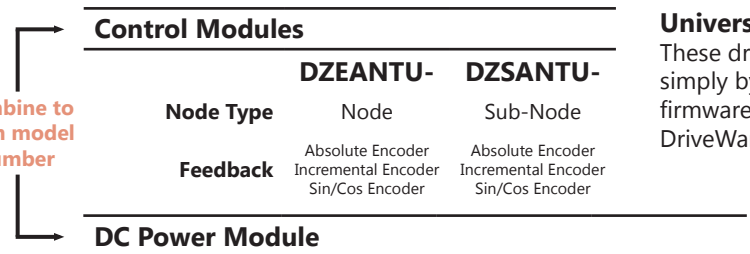

Universal Feedback

These drives support all the listed feedback devices simply by changing the drive firmware. The appropriate firmware can be uploaded to the drive through DriveWare® and is included with the software download.

Examples:
DZEANTU-020B080
DZSANTU-020B080

	020B080	040B080	020B200
Supply (VDC)	20-80	20-80	40-175
Peak Current (A)	20	40	20
Cont. Current (A)	10	20	10
Dimensions (mm)	90 x 64 x 20	90 x 64 x 20	90 x 64 x 20

DZE drives can be used as a stand-alone EtherCAT® node in a single-axis setup or as part of a larger multi-axis EtherCAT® network. DZS drives must be used as sub-nodes in a 'DxM' configuration with a DZE node.

ADVANCED Motion Controls offers mounting cards to simplify the connections between DZE/DZS drives and external system hardware (motors, feedback devices, controllers). These mounting cards are ideal for the prototyping and development stages as well as implementation into the final system design. The MC1XDZPE01 is designed to mount a DZE drive, while the MC4XDZP01 mounts one DZE drive and three DZS drives in a 'DxM' configuration.

Mounting Cards

	Axes	Motor/Power Connector	Max Voltage	Max Peak Current*
MC1XDZPE01	1	Side-entry screw terminal	175	40
MC4XDZP01	4	Side-entry screw terminal	175	40

*Per Axis

Mating Connector Kit

Mating connector housing and socket contacts can be ordered as a kit using ADVANCED Motion Controls' part numbers **KC-MC1XDZP01** for the MC1XDZPE01 and **KC-MC4XDZP01** for the MC4XDZP01.

Sold & Serviced By:



Toll Free Phone (877) SERV098
Toll Free Fax (877) SERV099
www.electromate.com
sales@electromate.com



DPR series - RS485/232 panel mount

Panel Mount Drives

DPR drives are enclosed by a metal cover and can be mounted on their spine or flat against the base.

Communication

- RS485/232 Networking and Drive Commissioning

Command Types

- Over the Network (All)
- +/-10V Analog (DPRAXIx)
- 24V Step and Direction (DPRAHIx)
- 5V Step and Direction (DPRXLxx)
- PWM and Direction (All)
- Encoder Following (All)
- Indexing (All)
- Jogging (All)

Power Range

- 1.5 - 27.4 kW Peak Power Output
- 0.8 - 13.7 kW Cont. Power Output

Primary Feedback

- Absolute Sin/Cos Encoder (Heidenhain EnDat® or Stegmann Hiperface®)
- 1Vp-p Sin/Cos Encoder
- Incremental Encoder
- Resolver

Auxiliary Feedback

- Hall Sensors
- Aux. Incremental Encoder
- Tachometer

To build a model number, select a control module by command (see Command Types above) and feedback type, then combine with a power module that suits your system's requirements. 24 VDC I/O Control Modules combine with AC Power Modules, and 5VTTL Control Modules combine with DC Power Modules.

RS-485/232 SERIAL



	24 VDC I/O Control Modules							
	Feedback	DPRAHIA- Absolute Encoder	DPRAHIE- Incremental Encoder	DPRAHIR- Resolver	DPRAHIS- Sin/Cos Encoder	DPRANIE- Incremental Encoder	DPRANIR- Resolver	DPRNLIE- Incremental Encoder
Example: DPRAHIE-030A400		015S400	015A400	030A400	C060A400	C100A400	030A800	060A800
Supply (VAC)		100-240*	100-240	100-240	200-240	200-240	200-480	200-480
Peak Current (A)		15	15	30	60	100	30	60
Cont. Current (A)		7.5	7.5	15	30	50	15	30
Dimensions (mm)		177 x 123 x 44	177 x 140 x 56	202 x 157 x 70	257 x 183 x 84	257 x 183 x 135	301 x 232 x 92	301 x 232 x 139

*Single Phase AC Only

	5VTTL I/O Control Modules		
	Feedback	DPRALTE- Incremental Encoder	DPRALTR- Resolver
Example: DPRALTR-040B080		020B080	040B080
Supply (VDC)		20-80	20-80
Peak Current (A)		20	40
Cont. Current (A)		10	20
Dimensions (mm)		133 x 90 x 36	191 x 112 x 36

Sold & Serviced By:
 ELECTROMATE

Toll Free Phone (877) SERV098
Toll Free Fax (877) SERV099
www.electromate.com
sales@electromate.com

ISO9001
CERTIFIED

cRU[®] US CE RoHS

**ADVANCED
MOTION CONTROLS**

DZR series - RS485/232 pcb mount

Z-Drives Plug-In Integration

DZR drives are packaged in a lightweight and compact form factor designed to be embedded directly into a PCB - no wires required! Inverted baseplate mounting also allows for direct wired connector access. A common footprint is used for the different power modules in the series to simplify prototyping.

Communication

- RS485/232 Networking and Drive Commissioning

Command Types

- Over the Network
- ±10V Analog
- 5V Step and Direction
- PWM and Direction
- Encoder Following
- Indexing
- Jogging

Power Range

- 0.9 - 4.6 kW Peak Power Output
- 0.5 - 2.3 kW Cont. Power Output

Primary Feedback

- Incremental Encoder

Auxiliary Feedback

- Hall Sensors
- Aux. Incremental Encoder
- Tachometer

To build a model number, combine a power module to meet your system's requirements with the DZRALTE control module.



RS-485/232
SERIAL



Combine to
form model
number

Control Module

DZRALTE-

Feedback

Incremental
Encoder

DC Power Modules

Example:
DZRALTE-040L080

	012L080	020L080	040L080	060L080	010L200	025L200
Supply (VDC)	20-80	10-80	10-80	10-80	40-175	40-175
Peak Current (A)	12	20	40	60	10	25
Cont. Current (A)	6	12	20	30	5	12.5
Dimensions (mm)	64 x 51 x 18	64 x 51 x 23	76 x 51 x 23	76 x 51 x 23	64 x 51 x 23	76 x 51 x 23

ADVANCED Motion Controls offers mounting cards and mating connector kits to simplify the connections between DZR drives and external system hardware (motors, feedback devices, controllers). These mounting cards are ideal for the prototyping and development stages as well as implementation into the final system design.

Mounting Cards

	Axes	Motor/Power Connector	Max Voltage	Max Peak Current
MC1XDZR02	1	Side-entry screw terminal	175	40
MC1XDZR02-QD	1	Vertical-entry quick-disconnect	175	25
MC1XDZR02-HP1	1	Side-entry screw terminal	80	60

Mating Connector Kit

Mating connector housing and socket contacts can be ordered as a kit using *ADVANCED* Motion Controls' part number **KC-MC1XDZ02**.

Sold & Serviced By:

ELECTROMATE

Toll Free Phone (877) SERV098

Toll Free Fax (877) SERV099

www.electromate.com

sales@electromate.com



ISO9001
CERTIFIED

RoHS

CE

cULus

Analog Servo Drives



ADVANCED Motion Controls' family of Analog Servo Drives provide unparalleled benefits in both simplicity and performance. Drive setup and operation is more straightforward than digital drives, while achieving higher bandwidth and faster response times at a lower cost. Analog drive technology has been a staple of servo system solutions since day one, and our years of experience in building the highest quality products has created a solid and continuously improving selection of analog drives. A variety of command options, including $\pm 10V$ analog, PWM and Direction, dual Sine wave, and specialized electric vehicle commands make the *ADVANCED* Motion Controls' family of analog drives your best choice for proven servo solutions.



- **Built-in hardware protection - Over Current, Over Voltage, Over Temperature, Short Circuit**
- **DIP Switches and Potentiometers for loop tuning, current limit adjustments, and drive configuration**
- **Standard models for both brushed and brushless motor varieties**
- **Velocity feedback provided by incremental encoder, Hall Sensors, or tachometer**
- **Analog Position Loop control available**
- **Optical Isolation between high and low power signals standard on most models**
- **Current, Velocity, and Fault Monitor analog output signals**
- **Status LEDs for power and drive status**
- **Standard models in both Panel Mount, PCB Mount (Z-Drives), and Vehicle Mount (M/V™ Series Motor Controllers)**
- **Four quadrant regenerative operation**
- **Extended Environment versions available (AZX series Z-Drives)**

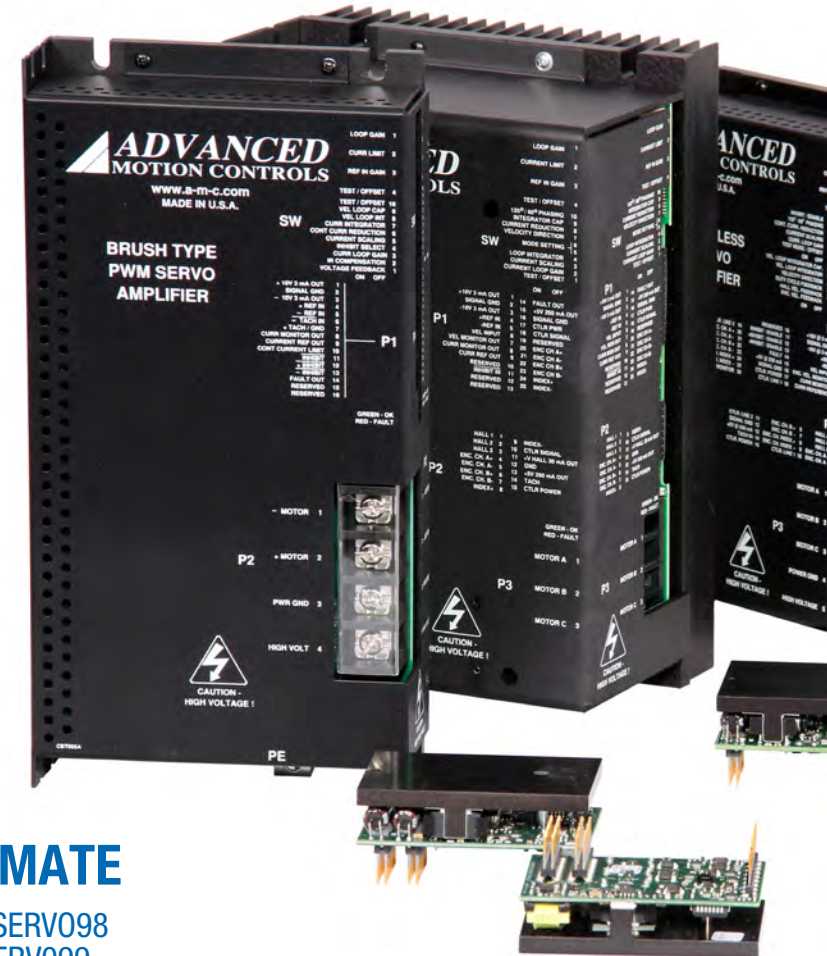

Sold & Serviced By:



Toll Free Phone (877) SERV098

Toll Free Fax (877) SERV099

www.electromate.com

sales@electromate.com



ANALOG SERVO DRIVES



Simplicity

Proven Track Record

Performance



Input Command Signals

±10 V Analog

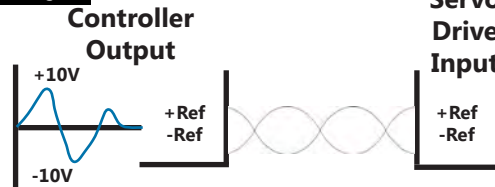

» Single-ended or differential ±10V analog input command used to adjust the motor current, voltage or speed.

PWM & Direction

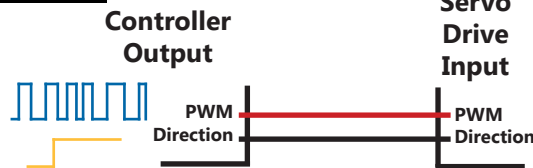

» Direct PWM - PWM & Direction signals translate directly to the output, providing direct control of the output duty-cycle and switching frequency. Direct PWM has the fastest response of all our products as there are no gain stages or integrators.
 » Torque Mode PWM - The PWM signal is converted to an analog voltage in the drive used as the command signal into the current loop (similar to current mode in other products). The input duty-cycle controls the drive's output current.

Dual Sine Wave

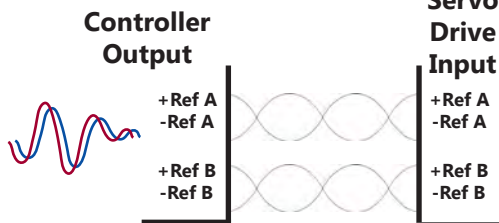

» Two sinusoidal command signals that correspond to the motor phase current that control the commutation and torque to the motor.



Sold & Serviced By:



Toll Free Phone (877) SERV098
 Toll Free Fax (877) SERV099
www.electromate.com
sales@electromate.com



B, BD, BE, and BX series - Brushless panel mount

Panel Mount Drives

These analog brushless drives are enclosed by a metal cover and can be mounted on their spine or flat against the base.

Command Types

- ±10V Analog
- Direct PWM and Direction ('BD' Drives)
- Torque Mode PWM and Direction ('BDC' Drives)

Potentiometers

- Loop Gain
- Current Limit
- Reference Gain
- Offset/Test Signal

Primary Feedback

- Hall Sensors
- Incremental Encoder
- Tachometer

Modes of Operation

- 'B' Drives - Current, Hall Velocity, Encoder Velocity
- 'BE' Drives - Encoder Velocity
- 'BX' Drives - Current, Hall Velocity, Encoder Velocity
- 'BD' and 'BDC' Drives - Torque Mode PWM, Direct PWM

Power Range

- 1.1 - 35.4kW Peak Power Output
- 0.6 - 17.7kW Cont. Power Output

To select a model number, choose a series based on the mode of operation, then find a model that matches your system's power requirements. Note that not all listed modes of operation are included on every drive in the series. Additional ordering options are also available. Consult the drive datasheet for specific modes and ordering options.

'B' Series Models - Current, Hall Velocity, Encoder Velocity

	Supply (VAC)	Supply (VDC)	Peak Current (A)	Cont. Current (A)	Dimensions (mm)
B15A8	-	20-80	15	7.5	129 x 76 x 25
BE15A8-H	-	20-80	15	7.5	129 x 76 x 25
B30A8	-	20-80	30	15	187 x 112 x 25
B25A20AC	30-125	40-190	25	12.5	187 x 107 x 62
B25A20I	-	40-190	25	12.5	187 x 112 x 25
B40A20I	-	40-190	40	20	187 x 112 x 25
B30A40	-	60-400	30	15	203 x 143 x 41
B30A40AC	45-265	60-400	30	15	203 x 166 x 103
B40A40AC	45-265	60-400	40	20	235 x 164 x 114
B40A40	-	60-400	40	20	235 x 159 x 64
B060A400AC	200-240	255-373	60	30	257 x 183 x 84
B100A400AC	200-240	255-373	100	50	257 x 183 x 135

'BX' Series Models - Current, Hall Velocity, Encoder Velocity

	Supply (VAC)	Supply (VDC)	Peak Current (A)	Cont. Current (A)	Dimensions (mm)
BX30A8	-	20-80	30	15	187 x 112 x 37
BX25A20AC	45-125	60-200	25	12.5	187 x 107 x 62
BX25A20	-	60-200	25	12.5	187 x 112 x 37

'BE' Series Models - Encoder Velocity

	Supply (VAC)	Supply (VDC)	Peak Current (A)	Cont. Current (A)	Dimensions (mm)
BE15A8	-	20-80	15	7.5	129 x 76 x 25
BE30A8	-	20-80	30	15	187 x 112 x 25
BE25A20AC	30-125	40-190	25	12.5	187 x 107 x 62
BE25A20I	-	40-190	25	12.5	187 x 112 x 25
BE40A20I	-	40-190	40	20	187 x 112 x 25

'BD' Series Models - Direct PWM

	Supply (VAC)	Supply (VDC)	Peak Current (A)	Cont. Current (A)	Dimensions (mm)
BD15A8	-	20-80	15	7.5	129 x 76 x 25
BD30A8	-	20-80	30	15	187 x 112 x 25
BD25A20AC	30-125	40-190	25	12.5	187 x 107 x 62
BD25A20I	-	40-190	25	12.5	187 x 112 x 25

'BDC' Series Models - Torque Mode PWM

	Supply (VAC)	Supply (VDC)	Peak Current (A)	Cont. Current (A)	Dimensions (mm)
BDC30A8	-	20-80	30	15	187 x 112 x 37
BDC40A20	-	60-190	40	20	187 x 112 x 37

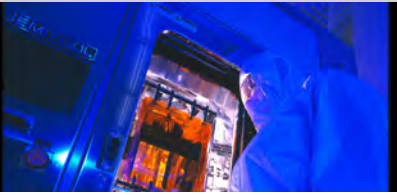

Sold & Serviced By:
 **ELECTROMATE**
 Toll Free Phone (877) SERV098
 Toll Free Fax (877) SERV099
www.electromate.com
sales@electromate.com

ISO9001
CERTIFIED

cRU[®] US CE RoHS

ADVANCED
MOTION CONTROLS

AZ series - Brushless/Brushed pcb mount

Z-Drives Plug-In Integration

AZ drives are packaged in a lightweight and compact form factor designed to be embedded directly into a PCB - no wires required! Inverted baseplate mounting also allows for direct wired connector access. A common footprint is used for the different power modules in the series to simplify prototyping.

Command Types

- ±10V Analog
- PWM and Direction (Torque Mode)

Modes of Operation

- Current
- Encoder Velocity
- Hall Velocity
- Duty Cycle (Open Loop)
- Torque Mode PWM

Power Range

- 0.3 - 4.6kW Peak Power Output
- 0.2 - 2.3kW Cont. Power Output

Primary Feedback

- Hall Sensors
- Incremental Encoder
- Tachometer

Potentiometers

- Loop Gain
- Offset

To build a model number, select a control module based on the desired mode of operation, then combine with a power module to meet your system's requirements.



	AZ Control Modules				DC Power Modules							
	AZB...	AZBE...	AZBH...	AZBDC...	10A4	6A8	12A8	20A8	40A8	60A8	10A20	25A20
Operating Mode	Current	Encoder Velocity Duty Cycle	Hall Velocity Duty Cycle	Torque Mode PWM								
Supply (VDC)	10-36	20-80	20-80	10-80	10-80	10-80	10-80	40-175	40-175			
Peak Current (A)	10	6	12	20	40	60	10	25				
Cont. Current (A)	5	3	6	12	20	30	6	12.5				
Dimensions (mm)	38 x 38 x 7	64 x 51 x 17	64 x 51 x 17	64 x 51 x 23	76 x 51 x 23	76 x 51 x 23	64 x 51 x 23	76 x 51 x 23				

Examples:
AZB20A8
AZBE40A8
AZBDC6A8

Combine to form model number

ADVANCED Motion Controls offers mounting cards to simplify the connections between AZ drives and external system hardware (motors, feedback devices, controllers). These mounting cards are ideal for the prototyping and development stages as well as implementation into the final system design.

Mounting Cards				
	Axes	Motor/Power Connector	Max Voltage	Max Peak Current
MC1XAZ01	1	Vertical-entry quick-disconnect	175	25
MC1XAZ01-HR	1	Side-entry screw terminal	175	60

Sold & Serviced By:

ELECTROMATE

Toll Free Phone (877) SERV098

Toll Free Fax (877) SERV099

www.electromate.com

sales@electromate.com



ISO9001
CERTIFIED

RoHS

CE

cUL US

Brushed panel mount

Panel Mount Drives

These analog brushed drives are enclosed by a metal cover and can be mounted on their spine or flat against the base.

Command Types

- $\pm 10V$ Analog
- Direct PWM and Direction

Potentiometers

- Loop Gain
- Current Limit
- Reference Gain
- Offset/Test Signal

Power Range

- 0.6 - 38kW Peak Power Output
- 0.3 - 19kW Cont. Power Output

Primary Feedback

- Tachometer

Modes of Operation ($\pm 10V$ Analog)

- Current
- Voltage
- IR Compensation
- Velocity

Modes of Operation (PWM and Dir)

- Direct PWM Current Mode

To select a model number, choose a series based on the command type, then find a model that matches your system's power requirements.

Brushed $\pm 10V$ Analog Command Models

	Supply (VAC)	Supply (VDC)	Peak Current (A)	Cont. Current (A)	Dimensions (mm)
12A8	-	20-80	12	6	129 x 76 x 25
25A8	-	20-80	25	12.5	129 x 76 x 25
30A8	-	20-80	30	15	187 x 112 x 25
50A8	-	20-80	50	25	187 x 112 x 25
120A10	-	20-80	120	60	254 x 130 x 49
16A20AC	30-125	40-190	16	8	187 x 107 x 62
20A20	-	40-190	20	10	129 x 76 x 25
25A20I	-	40-190	25	12.5	187 x 112 x 25
30A20AC	30-125	40-190	30	15	187 x 107 x 62
50A20I	-	40-190	50	25	187 x 112 x 25
100A40	-	80-400	100	50	235 x 183 x 92

Brushed PWM and Direction Command Models

	Supply (VAC)	Supply (VDC)	Peak Current (A)	Cont. Current (A)	Dimensions (mm)
30A8DD	-	20-80	30	15	187 x 112 x 25
50A8DD	-	20-80	50	25	187 x 112 x 25
25A20DD	-	40-190	25	12.5	187 x 112 x 25
50A20DD	-	40-190	50	25	187 x 112 x 25



ISO9001
CERTIFIED

cRU[®] US CE RoHS

ADVANCED
MOTION CONTROLS

Sold & Serviced By:

 **ELECTROMATE**

Toll Free Phone (877) SERV098

Toll Free Fax (877) SERV099

www.electromate.com

sales@electromate.com

S series - Sinusoidal commutation drives

Panel Mount Drives

These sinusoidal drives are enclosed by a metal cover and can be mounted on their spine or flat against the base.

Power Range

- 1.2 - 38kW Peak Power Output
- 0.6 - 19kW Cont. Power Output

Mode of Operation

- Current

Command Types

- 120° Sine

S series drives are the only analog drives offered by *ADVANCED* Motion Controls with sinusoidal commutation (all digital DigiFlex® Performance™ models use sinusoidal commutation). S series drives require two specialized sinusoidal command signals from an external controller that correspond to the motor phase currents and control the commutation and torque to the motor.

To select a model number, choose a model that matches your system's power requirements.

'S' Series Models					
	Supply (VAC)	Supply (VDC)	Peak Current (A)	Cont. Current (A)	Dimensions (mm)
S16A8	-	20-80	16	8	129 x 78 x 39
SX25A20	-	60-190	25	12.5	187 x 112 x 37
S30A40	-	60-400	30	15	203 x 143 x 41
S30A40AC	45-270	60-380	30	15	203 x 166 x 103
S60A40	-	60-400	60	30	235 x 160 x 89
S60A40AC	45-270	60-380	60	30	235 x 162 x 155
S100A40	-	60-400	100	50	271 x 234 x 92

All motor feedback is returned to the controller, which tracks the motor rotor position and outputs the correct signals to the drive in order to maintain the proper phase angle.

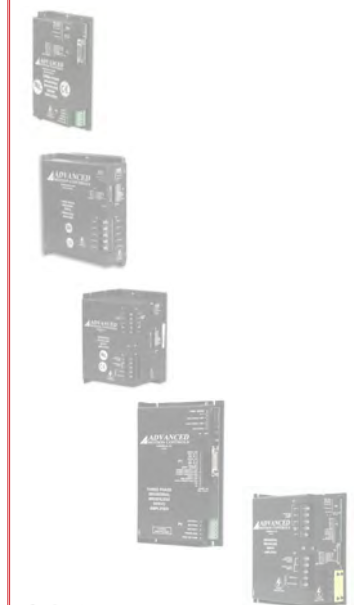

ISO9001
CERTIFIED

RoHS CE cRU US

Sold & Serviced By:



Toll Free Phone (877) SERV098
Toll Free Fax (877) SERV099
www.electromate.com
sales@electromate.com



Extended Environment Servo Drives



ADVANCED Motion Controls' Extended Environment products are designed to operate under harsh thermal and mechanical extremes. An expanded thermal operating range allows these drives to function in both hot and cold ambient environments, and enhanced protection against shock and vibration provides additional system ruggedness. Extended Environment drives also afford benefits for applications in more docile conditions. The superior thermal capabilities reduce or eliminate the need for cooling systems such as external heat sinks and fans, enabling system designs to be more compact and to improve overall reliability.

Shock

&

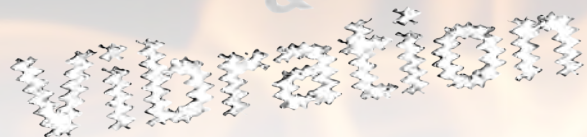

- Ambient operating temperatures ranging from -40°C to 85°C (-45°F to 185°F)
- Over Temperature heat sink protection up to 105°C (221°F)
- Thermal rise cycling in about 2 minutes
- Shock up to 15g's at 11ms
- Vibration up to 30grms on all 3 axes
- Standard models in PCB Mount (Z-Drives) form factor - Panel Mount models available as custom designs
- Designed to assist system compliance toward:
 - » MIL-STD-810F: temperature, thermal shock, humidity, altitude, shock & vibration
 - » MIL-STD-1275D: characterization of 28VDC systems
 - » MIL-STD-461E: control of electromagnetic interference
 - » MIL-STD-704F: aircraft power characteristics
 - » MIL-HDBK-217: reliability predictions
- Tested to meet above standards upon customer request

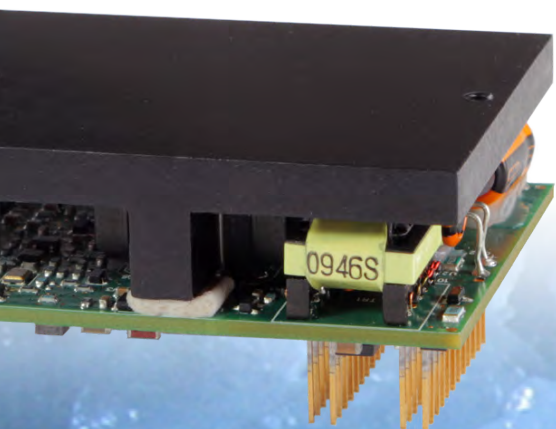

Sold & Serviced By:

 **ELECTROMATE**

Toll Free Phone (877) SERV098

Toll Free Fax (877) SERV099

www.electromate.com

sales@electromate.com

Extended Environment Servo Drives

Sold & Serviced By:

 **ELECTROMATE**

Toll Free Phone (877) SERV098

Toll Free Fax (877) SERV099

www.electromate.com

sales@electromate.com

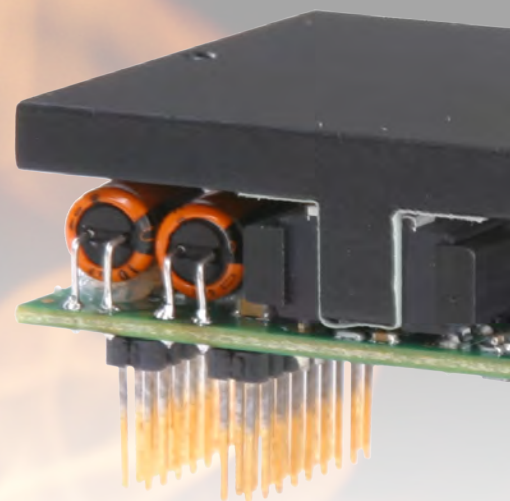

DZ^X series

- » User selected I/O and Event Handling
- » Configurable limits & gains
- » Distributed network control
- » Comprehensive diagnostics

AZ^X series

- » Highest bandwidth possible
- » Dedicated operating modes
- » Highest operating temperature
- » Simplest installed platform

-40°C
AZX/DZX Series

+75°C
DZX Series

+85°C
AZX Series

+100°C and higher!
Custom Drives

DZX series - Extended Environment digital pcb mount



CANopen
RS-485/232
SERIAL



Z-Drives Plug-In Integration

DZX drives are packaged in a lightweight and compact form factor designed to be embedded directly into a PCB - no wires required! Inverted baseplate mounting also allows for direct wired connector access. A common footprint is used for the different power modules in the series to simplify prototyping.

Communication

- CANopen or RS485/232 Networking
- RS232 Drive Commissioning

Command Types

- Over the Network
- ±10V Analog
- 5V Step and Direction
- PWM and Direction
- Encoder Following
- Indexing
- Jogging

Power Range

- 0.6 - 3kW Peak Power Output
- 0.3 - 1.5kW Cont. Power Output

Extended Environment

- -40°C to +75°C Ambient Operating Range
- Shock up to 15g's
- Designed to Environmental Engineering Considerations as defined in MIL-STD-810F

Primary Feedback

- Incremental Encoder

Auxiliary Feedback

- Hall Sensors
- Aux. Incremental Encoder
- Tachometer

To build a model number, select a control module based on network communication type, then combine with a power module

	DZX Control Modules		
	Network	DZXCANTE- CANopen	DZXRALTE- RS485/232
Example: DZXCANTE-040L080	DC Power Modules		
		008L080	015L080
Supply (VDC)	10-80	10-80	10-80
Peak Current (A)	8	15	40
Cont. Current (A)	4	7.5	20
Dimensions (mm)	64 x 51 x 24	64 x 51 x 24	76 x 51 x 23

ADVANCED Motion Controls offers mounting cards to simplify the connections between DZX drives and external system hardware (motors, feedback devices, controllers). These mounting cards are ideal for the prototyping and development stages as well as implementation into the final system design.

Mounting Cards*

	Axes	Motor/Power Connector	Max Voltage	Max Peak Current
MC1XDZx02	1	Side-entry screw terminal	175	40
MC1XDZx02-QD	1	Vertical-entry quick-disconnect	175	25
MC1XDZx02-HP1	1	Side-entry screw terminal	80	60

*Replace "x" in the model number with "C" for DZXCANTE drives or "R" for DZXRALTE drives

Mating Connector Kit

Mating connector housing and socket contacts can be ordered as a kit using ADVANCED Motion Controls' part number **KC-MC1XDZ02**.

Sold & Serviced By:
ELECTROMATE
Toll Free Phone (877) SERV098
Toll Free Fax (877) SERV099
www.electromate.com
sales@electromate.com

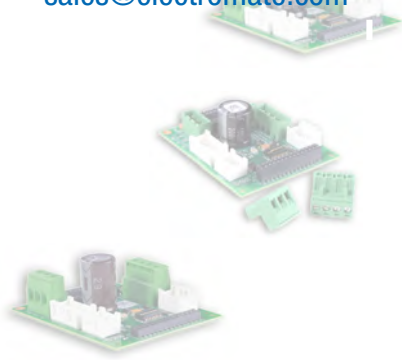

cRU[®] US CE RoHS

ADVANCED
MOTION CONTROLS

AZX series - Extended Environment analog pcb mount

Z-Drives Plug-In Integration

AZX drives are packaged in a lightweight and compact form factor designed to be embedded directly into a PCB - no wires required! Inverted baseplate mounting also allows for direct wired connector access. A common footprint is used for the different power modules in the series to simplify prototyping.

Command Types

- ±10V Analog
- PWM and Direction (Torque Mode)

Modes of Operation

- Current
- Encoder Velocity
- Hall Velocity
- Duty Cycle (Open Loop)
- Torque Mode PWM

Extended Environment

- -40°C to +85°C Ambient Operating Range
- Shock up to 15g's
- Designed to Environmental Engineering Considerations as defined in MIL-STD-810F

Primary Feedback

- Hall Sensors
- Incremental Encoder
- Tachometer

Potentiometers

- Loop Gain
- Offset

Power Range

- 0.6 - 1.9kW Peak Power Output
- 0.3 - 1.0kW Cont. Power Output

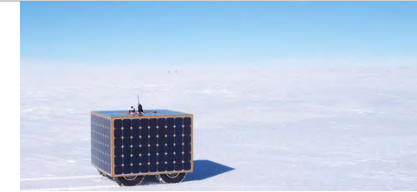

Combine to form model number	AZX Control Modules			
	AZXB...	AZXB...	AZXBH...	AZXBDC...
Operating Mode	Current	Encoder Velocity Duty Cycle	Hall Velocity Duty Cycle	Torque Mode PWM
DC Power Modules				
	8A8	15A8	25A8	
Supply (VDC)	10-80	10-80	10-80	
Peak Current (A)	8	15	25	
Cont. Current (A)	4	7.5	12.5	
Dimensions (mm)	64 x 51 x 23	64 x 51 x 23	76 x 51 x 23	

Examples:
AZXB8A8
AZXBDC15A8

Combine to form model number

Combine to form model number

Combine to form model number

Combine to form model number

ADVANCED Motion Controls offers mounting cards to simplify the connections between AZX drives and external system hardware (motors, feedback devices, controllers). These mounting cards are ideal for the prototyping and development stages as well as implementation into the final system design.

Mounting Cards

	Axes	Motor/Power Connector	Max Voltage	Max Peak Current
MC1XAZ01	1	Vertical-entry quick-disconnect	175	25
MC1XAZ01-HR	1	Side-entry screw terminal	175	60

Sold & Serviced By:

ELECTROMATE

Toll Free Phone (877) SERV098

Toll Free Fax (877) SERV099

www.electromate.com

sales@electromate.com

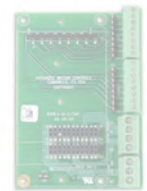

RoHS

CE

cRU^{us}

M/V™ Series Vehicle Mount Motor Controllers



ADVANCED Motion Controls' family of M/V™ series vehicle mount motor controllers are fully functional, four-quadrant servo drives purpose designed and built to operate today's modern mobile electric vehicular platforms. Available in both analog and digital versions and packaged in a compact and rugged IP65 case, M/V series motor controllers provide high power from battery supplies for either permanent magnet brushed or brushless motors. Whether for traction / propulsion, steering, lifting, or any other electrically driven actuation, the unmatched power density, high efficiency, low weight, built-in regen, and cool thermal operation of M/V series motor controllers provide optimum performance for mobile electric vehicular applications.



20-54 VDC 250 A. peak 150 A. cont	20-80 VDC 200 A. peak 125 A. cont	40-175 VDC 125 A. peak 80 A. cont	40-175 VDC 100 A. peak 100 A. cont
---	---	---	--

Sold & Serviced By:

 **ELECTROMATE**

Toll Free Phone (877) SERV098

Toll Free Fax (877) SERV099

www.electromate.com

sales@electromate.com

- **Analog (AVB, AB) and Digital (DVC) models provide solutions for a wide range of command, configuration, and network options**
- **Selectable throttle command inputs: 0-5V or 0-5kΩ**
- **Standard and vehicle-specific I/O for over 60 events and signals**
- **Compact, Rugged, Vehicle Mount Design - IP65 Rating**
- **Watertight I/O, signal, and feedback connector**
- **Watertight access panel for drive configuration and setup**
- **Selectable modes of operation**
- **DVC models configurable through DriveWare® 7, offering the same capabilities range of DigiFlex® Performance™ digital servo drives**
- **AVB and AB models configurable through DIP Switches and potentiometers**



M/V™ SERIES MOTOR CONTROLLERS



Vehicle Specific I/O

M/V series motor controllers feature unique programmable and dedicated inputs and outputs designed with mobile electric vehicular applications in mind.

- Key Switch / Main Contactor Operation
- Electromagnetic Holding Brake Output
- Speed Limit Input
- Reduced Speed Reverse
- Forward / Reverse Inputs
- "Push" (Neutral) Input
- Horn / Reverse Alarm

Throttle Command Inputs

M/V series motor controllers are configurable for a variety of different throttle command types common in electric vehicular applications. Each command type is user-selectable as standard single-ended, inverse single-ended, wigwag, or inverse wigwag.

0-5V Analog Voltage

On DVC and AVB models, an external 0 - 5 volt supply provides the command input source.

0-5kΩ Potentiometer

On DVC and AVB models, an external 5kΩ potentiometer can be used in either a 3-wire or 2-wire configuration to provide the command source.

±10V Analog

On DVC and AB models, an external or on-board ±10 volt supply provides the command input source.

Sold & Serviced By:



Toll Free Phone (877) SERV098

Toll Free Fax (877) SERV099

www.electromate.com

sales@electromate.com



DVC series - vehicle mount digital motor controllers

Vehicle Mount Drives

M/V™ drives are packaged in an IP65 ruggedized enclosure designed for mounting in electric vehicles.

Communication

- CANopen Networking
- USB Drive Commissioning

Power Range

- 12.8 - 20.8 kW Peak Power Output
- 7.7 - 16.6 kW Cont. Power Output

Command Types

- Over the Network
- ±10V Analog
- Indexing
- Jogging

Electric Mobility and Vehicle I/O

- Electromagnetic Holding Brake Output
- Forward and Reverse Inputs
- Push Brake Release Input
- Speed Limit Pot Input
- Reduced Speed Reverse Input
- Safe Torque Off Inputs

Primary Feedback

- Incremental Encoder

Auxiliary Feedback

- Hall Sensors
- Tachometer

To build a model number combine the DVC control module with a power module to meet your system's requirements.

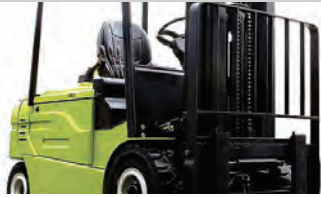

M/V™ series
Electric Vehicle Motor Controls



	M/V™ Digital Control Module		DC Power Modules	
	Network	DVC... CANopen		
Examples: DVC250A060			250A060	200A100
Supply (VDC)	20-54	20-80	40-175	40-175
Peak Current (A)	250	200	125	100
Cont. Current (A)	150	125	80	100
Dimensions (mm)	203 x 140 x 60	203 x 140 x 60	203 x 140 x 60	203 x 140 x 60

Vehicle Throttle Commands

On DVC models, the command input type is selected through DriveWare:

- **Wigwag/Single-Ended Command Input**
- **3-Wire / 2-Wire External Potentiometer Command Source**
- **Standard / Inverted Inputs**
- **Reduced Speed Reverse**

Safe Torque Off

DVC models feature dedicated Safe Torque Off (STO) inputs that prevent any current-generating energy from reaching the motor. Functional Safety STO meets SIL 3 per IEC 61800-5-2; tested by NRTL.

Mating Connector Kit

Mating connector housing, socket contacts, and seal plugs can be ordered as a kit using **ADVANCED Motion Controls'** part number **KC-35AMPSEAL01**.



Sold & Serviced By:

ELECTROMATE

Toll Free Phone (877) SERV098

Toll Free Fax (877) SERV099

www.electromate.com

sales@electromate.com

AVB/AB series - vehicle mount analog motor controllers

Vehicle Mount Drives

M/V™ drives are packaged in an IP65 ruggedized enclosure designed for mounting in electric vehicles.

Command Types

- ±10V Analog
- 0-5kΩ Potentiometer
- 0-5V Analog

Power Range

- 12.8 - 20.8 kW Peak Power Output
- 7.7 - 16.6 kW Cont. Power Output

Potentiometers

- Loop Gain
- Current Limit
- Reference Gain
- Offset/Test Signal
- Ramp Time
- Deadband

Electric Mobility and Vehicle I/O

- Electromagnetic Holding Brake Output
- Forward and Reverse Inputs
- Push Brake Release Inputs
- Speed Limit Pot Input
- KeySwitch Master Input

Primary Feedback

- Hall Sensors
- Incremental Encoder
- Tachometer

Modes of Operation

- Current
- Voltage
- Duty Cycle (Open Loop)
- IR Compensation
- Velocity
- Hall Velocity



To build a model number, select a control module based on the application category, then combine with a power module to meet your system's requirements.



M/V™ series
Electric Vehicle Motor Controls



Combine to form model number

M/V™ Analog Control Modules					
	AVB...	AB...			
Applications	Electric Mobility and Vehicle	General Industrial			
	250A060	200A100	125A200	100C200	
Supply (VDC)	20-54	20-80	40-175	40-175	
Peak Current (A)	250	200	125	100	
Cont. Current (A)	150	125	80	100	
Dimensions (mm)	203 x 140 x 60	203 x 140 x 60	203 x 140 x 60	203 x 140 x 60	

Examples:
AVB250A060
AB125A200

Vehicle Throttle Commands

On AVB models, DIP switches are used to select the command input type:

- **Wigwag/Single-Ended Command Input**
- **3-Wire / 2-Wire External Potentiometer Command Source**
- **Standard / Inverted Inputs**
- **Half Speed Reverse**

Mating Connector Kit

Mating connector housing, socket contacts, and seal plugs can be ordered as a kit using *ADVANCED* Motion Controls' part number **KC-23AMPSEAL01**.



Sold & Serviced By:

 **ELECTROMATE**

Toll Free Phone (877) SERV098

Toll Free Fax (877) SERV099

www.electromate.com

sales@electromate.com

RoHS

CE

cRU^{us}

ADVANCED
MOTION CONTROLS

Custom Servo Drive Capabilities

ADVANCED Motion Controls has the capability to promptly develop and deliver specified products for OEMs with volume requests. Our Applications and Engineering Departments will work closely with your design team through all stages of development in order to provide the best servo drive solution for your system.

Equipped with on-site engineering and manufacturing for quick-turn customs capabilities, *ADVANCED* Motion Controls utilizes our years of expertise to decrease your costs and time-to-market while increasing system quality and reliability.

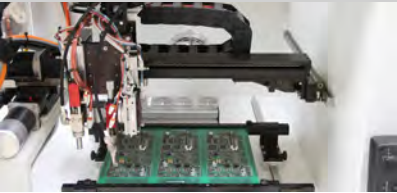

Two on-site full SMT production lines, and four on-site engineering labs will design and support OEM solutions as if they were standard products!

ADVANCED Motion Controls has extensive experience in designing affordable custom products optimized for OEM's specific needs. Whether a simple modification to a standard product or a completely custom design, we can support and sell custom solutions as if they were standard products.

Examples of Customized Products and Options

- Optimized Footprint
- Private Label Software
- OEM Specified Connectors
- No Outer Case
- Increased Current Resolution
- Increased Temperature Range
- Custom Control Interface
- Integrated System I/O
- Tailored Project File
- Silkscreen Branding
- Optimized Base Plate
- Increased Current Limits
- Increased Voltage Range
- Conformal Coating
- Multi-Axis Configurations
- Reduced Profile Size and Weight



ISO9001
CERTIFIED



Sold & Serviced By:

ELECTROMATE

Toll Free Phone (877) SERV098

Toll Free Fax (877) SERV099

www.electromate.com

sales@electromate.com

cRU^{us} CE RoHS

ADVANCED
MOTION CONTROLS





Custom products are built on the same equipment and with the same people as if they were production units, enabling rapid development and fast delivery, as well as making it easy to make changes before the product is released to production.



An ISO 9001:2008 certified online documentation workflow insures accuracy and consistency throughout design, manufacturing, testing, and support of all products.

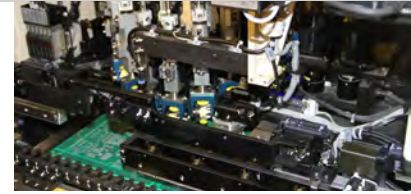

Sold & Serviced By:

 **ELECTROMATE**

Toll Free Phone (877) SERV098

Toll Free Fax (877) SERV099

www.electromate.com

sales@electromate.com



Advantages to a custom solution with **ADVANCED** Motion Controls:

- Reduce project development time and cost
- Simplify integration of motor, controller, power supply, feedback
- Precisely match sizing requirements



Feel free to contact our Applications Engineering department for more information on custom solutions!





Partnering with **ADVANCED** Motion Controls

- » Superior performance and product offering
- » Fast delivery to meet your needs
- » Worldwide factory trained technical and sales support
- » Engineering support available to you on-site
- » Close collaboration with, and an extension of, your engineering team
- » Diverse industrial experiences and knowledge allows us to improve your systems
- » Proud of providing you with the most optimized solutions
- » Passionate about your success

Providing motion control solutions to OEMs is our focus...

Sold & Serviced By:



Toll Free Phone (877) SERV098
Toll Free Fax (877) SERV099
www.electromate.com
sales@electromate.com

Everything's possible